

QWP Separation & Mass Transfer Solutions



Product Catalogue
and Technical Specifications



Welcome

Quality Wire Products Company

Quality Wire Products Co W.L.L is one of the single largest sources in the Middle East for supply of wire mesh related products. We offer a complete range of wire mesh and perforated sheet products which are used in the separation; insulation and industrial application.

With variety of products offered under one roof we have the pride to inform our traders/partners to open stores to stock and sell only our line of products.

With stocks and inventories of finished goods valued more than 5Million dollars and with complete line of products enclosed above we can ship a consolidated order in a container with each line of products in small quantity there by reducing the transportation/shipping cost and maintain minimum stock level at the customer stores. This concept has become very successful and with this concept we are exporting our products to more than 20 countries and we are proud to say that we have become the single largest source to supply all types of wire mesh products under one roof.

Product Catalogue and Technical Specifications

Quality Wire Products

QWP Separation & Mass Transfer Solutions	01
Mist Eliminators	08
Wedge Wire Screens	11
Catalyst/Packed Beds	12
Tower Packings	13
Structured Packings	14
Strainers	15
Coalescers	16
Certifications	18

INLET & OUTLET DEVICES

Inlet & Outlet Devices are used for effective high energy transfer of incoming flow media. They are manufactured in wedge wire screens, perforated screens and plain thick metal sheets according to the process conditions and requirements.

- Inlet Distributors**
- Vane Type Inlet Devices**
- Outlet Devices**



Inlet Distributors

Inlet distributors are typically made up of perforated baskets lined with fine mesh with sizes from 2" upto 52".



Vane Type Inlet Devices

Vane Type inlet devices are designed to withstand high momentum and are suitable for two phase or three phase separators both in vertical and horizontal

configurations. The sizes are dictated by the process conditions and the thickness is available in 3mm or 5mm with respect to sludge formation.



Outlet Devices

Outlet Collectors are also typically made up of perforated baskets lined with fine mesh with sizes from 2" upto 52". They are used in conjunction with Inlet distributors at either inlet/outlet ends.



LIQUID-LIQUID SEPARATION

These devices aid in breaking liquid waves in the liquid levels and aid in the separation of lighter liquid from the heavier liquid in a three-phase or four-phase separator.

- Calming perforated baffles**
- Plate Packs**



Calming perforated baffles

Calming perforated baffles come in a set with the first baffle acting as a primary separation device while the secondary baffle has more open area than the former. This set of baffles subside the turbulence of fluids entering the separators. This negation of un-even flow enables for an increase in efficiency of the plate pack that is placed right after the baffles.



Plate Packs

Coalescing Plate packs aid in the final stage of liquid-liquid separation. The corrugated plates which are stacked closely aids in coalescing the smaller droplets into larger chunks of oil droplets which increases the efficiency of separation from water. Plate packs are essential components of liquid-liquid separation and make sure that the oil in water and water in oil criteria are met. Coalescing media made of thick metallic mesh are also used when the droplets are too small, as an initial buffer before the metallic sheet based plate pack.



DEMISTING DEVICES

Demisting devices are usually positioned near the outlet nozzle of any scrubber or vessel or column. They offer a cost-effective and an efficient replaceable filter solution for wide range of industries from Oil & Gas Industries right through to desalination plants.

Demisters

Demisters are fit across in horizontal, vertical, rectangular and other shape vessels or installation banks according to design needs. They are wire mesh-based filters that offer excellent performance at a relatively low cost. The vapor phase of the incoming media is passed through the demister which forms an efficient barrier for the liquid droplets entrained in the media flow which later drain as droplets. When there is a restriction in space drain pipes are also placed in contact



with the demister which can absorb extra amount of droplets. These demisters can be manufactured in various kinds of shapes depending on the end use.

Demisters
Vane Pack
Cyclones



Vane Pack

Vane packs are metal sheet based demisters which offer robust performance for particles sizes that are slightly higher than that are filtered by demisters. This is however more than compensated for its perfor-

mance at higher velocity when compared to wire mesh based demisters. Vane packs contain stacked corrugated plates that are evenly spaced to form barriers for the liquid droplets to collide against.

Cyclones

Cyclones are extremely high velocity devices that surpass both vane packs and demister pads performance at the cost of lower separation efficiency for lower sized particles. They are however very efficient and aid in substantially smaller vessel



designs. They are popularly also used in retrofit designs to improve the capacity of the vessel.

CATALYST & PACKING SUPPORT

Packed Catalyst beds need floating screens reinforced structural grids to carry the enormous weights exerted by the internals in a vessel along with the flow of media inside.

- Catalyst Beds
- Random Packing Bed Support
- Structured Packing bed support



Catalyst Beds

Catalyst beds are made of wedge wire screens or structured gratings in various alloy grades with proper structural calculations. These beds are used for facilitating the catalyst media retention and even feed

distribution. The catalyst beds are provided with additional design advice on the support and come with easy to fix hardware for efficient installation.

Random Packing Bed Support

Random packing bed supports ensure the random packed bed load is supported and there is an efficient flow of liquid media downstream to the sump.

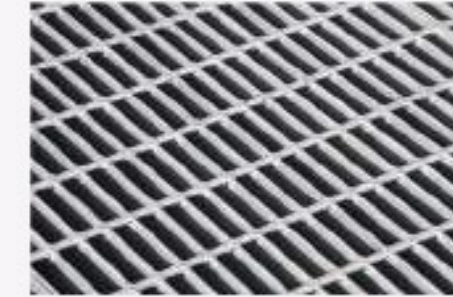
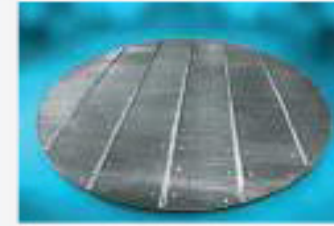
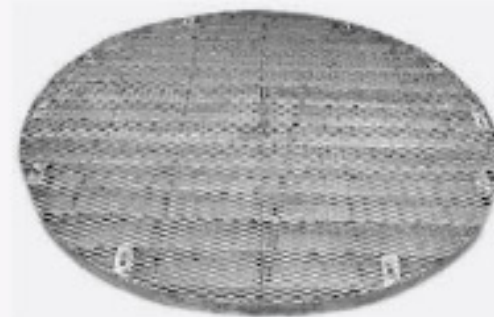

Structured Packing bed support

Structured packing bed supports are generally larger than random packing bed supports. These beds come with bed limiters and stainless steel or higher alloy grade gratings. The operating performance also rests on two important principles

namely enabling unrestricted flow of downcoming flow not interrupting the upward direction flowing vapor phase, and ensuring mechanical integrity of the structured packing bed.

GAS LIQUID SEPARATION

Mass Transfer technology use liquid as a desiccant to remove the unwanted liquid in the gas. Internals such as Trays, packings help facilitate this interaction and help in making sure the gas flowing upwards contains less liquid while the removed liquid falls downwards to the sump.

- Random packings
- Structured Packings
- Trays



Random packings

Random packings are ideally suited for small columns due to their inexpensive cost and easy replacement. They are available in metallic, plastic and ceramic material according to the nature of service. These packings reduce pressure drop, have increased capacity when compared to trays and make sure liquid flows across the column uniformly with minimum liquid levels accumulated.



Structured Packings

Structured packings are normally used in large columns and are more efficient with respect to even distribution all across the column when compared to random packings. These structured packings are made up of extremely thin corrugated sheets packed together.





Trays

Trays are usually used in high distillation columns and also used in conjunction with packings. The range is wide varied with designs like conventional sieve trays, shed trays, valve trays, bubble cap tray with



constant research to amplify gains by tweaking design features in conventional trays.

OIL & GAS VESSEL & COLUMN PACKAGES

The vessels and their configurations are process specific. We at quality wire products offer complete packages from process design, CFD analysis, manufacturing of vessel internals and delivery upto your plant.

Horizontal Vessels
Vertical Vessels & Columns



Vertical Vessels & Columns

We can design and manufacture internals for scrubbers, compressor suction drums, knock out drums, two phase separators



Horizontal Vessels

Horizontal vessels are usually for three phase separation and are ideal due to the flexibility in length of tangent to tangent lines of vessels.

POWER & DESALINATION FILTRATION SOLUTIONS

Power and desalination plants have stringent regulations to ensure there is minimal environmental costs while producing basis utilities.

Demisting Devices
Air Filters
Miscellaneous Hardware



Demisting Devices

We design and manufacture demisters in mesh and sheet styles for Multi-Effect Distillation and Multi Stage Flash distillation units.



PETROCHEMICAL PLANT FILTRATION SOLUTIONS

Petrochemical plants are highly critical industries where we support for a wide range of products

Demisting Devices
Floating Screens
Filter Elements & Miscellaneous Hardware



Air Filters

Air filters come in different configurations but are mainly used for filtration of air in critical parts of a desalination plant

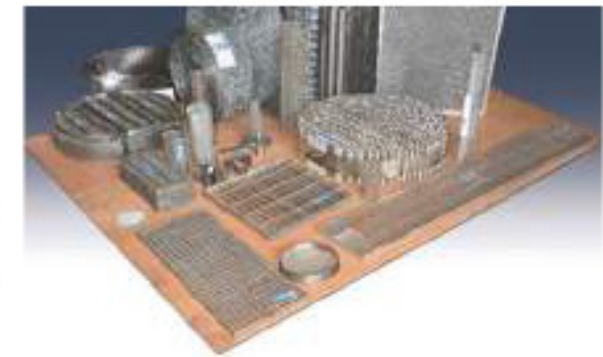

Miscellaneous Hardware

We also manufacture and supply all kinds of essential hardware such as wire mesh, filter elements. We also supply special alloy

materials in forms such as plates, sheets, pipes, rods etc in grades from SS 316L, 310S, Alloy 825, Monel, Inconel, Cu-Ni etc. We manufacture filter elements according to specific process requirements.



Demisting Devices

We manufacture demisters in mesh and sheet styles according to the drawings and provide like to like replacement of demisters in all grades. These demisters can be replaced swiftly for your emergency shutdowns.



Floating Screens

Circular woven wire mesh screens can be manufactured according to custom sizes and specifications with the choice of all metallic grades



Filter Elements & Miscellaneous Hardware

We also manufacture and supply all kinds of essential hardware such as wire mesh, filter elements. We also supply special alloy materials in forms such as plates, sheets, pipes, rods etc in grades from SS 316L, 310S, Alloy 825, Monel, Inconel, Cu-Ni etc. Cartridge filters and other special air filters also can be manufactured as per sample.

Demisting Devices

We manufacture demisters in mesh and sheet styles for scrubbers, compressor knock out drums and will ensure performance compliance for the whole unit. We also offer debottlenecking consultancy services for filtration unit to achieve required environmental regulations.



Metallic Conveyor Belt Solutions & Woven wire Mesh

Metal Conveyor belts provide longer lasting food/Industrial grade compliant mass transport solutions internally in a plant. The metallic grades and style of belts are can be tailored according to custom requirements.



Miscellaneous Hardware

We also manufacture and supply all kinds of essential hardware such as wire mesh, filter elements. We also supply special alloy materials in forms such as plates, sheets, pipes, rods etc in grades from SS 316L, 310S, Alloy 825, Monel, Inconel, Cu-Ni etc.

INDUSTRIAL PLANTS FILTRATION SOLUTIONS

We offer a wide range of products to Aluminium smelters, Iron and Steel Industries, waste water treatments plants, Food industries, Fire Fighting

- Demisting Devices
- Metallic Conveyor Belt Solutions & Woven wire Mesh
- Miscellaneous Hardware



QWP CS TYPE
(Custom Made)

On many cases Teflon, Polypropylene and Polyester mono & multifilament demisters are made upon special request from the customers. Mesh Pad Density, Surface area and free volume will be provided upon request. These type of meshes are called QWP/CS Type (CS stands for Custom made)

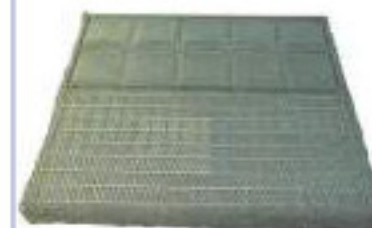

QWP Mist Eliminator Specifications – Stainless Steel All Grades				
QWP Type	Density Kg/m ³	Wire Surface Area m ² /m ³	Wire dia. mm	Free Volume%
Type : 1	75	135 to 160	0.25 to 0.28	99
Type : 2	80	142 to 160	0.25 to 0.28	99
Type : 2A	80	250 to 268	0.15 to 0.16	99
Type : 3	110	196 to 220	0.25 to 0.28	98.6
Type : 3A	110	343 to 366	0.15 to 0.16	98.6
Type : 4	128	228 to 266	0.25 to 0.28	98.4
Type : 4A	128	400 to 426	0.15 to 0.16	98.4
Type : 4B	136	228 to 266	0.25 to 0.28	98.4
Type : 4C	120	214 to 240	0.25 to 0.28	98.5
Type : 5	144	257 to 288	0.25 to 0.28	98.2
Type : 5A	160	267 to 300	0.25 to 0.28	98.125
Type : 5B	160	468 to 500	0.15 to 0.16	98.125
Type : 6	173	308 to 360	0.24 to 0.28	97.8
Type : 6A	175	312 to 360	0.24 to 0.28	97.8
Type : 7	193	344 to 386	0.25 to 0.28	97.58
Type : 7A	193	603 to 643	0.15 to 0.16	97.58
Type : 7B	195	348 to 390	0.25 to 0.28	97.56
Type : 7C	195	609 to 650	0.15 to 0.16	97.56
Type : 7D	191	341 to 382	0.25 to 0.28	97.62
Type : 8	214	382 to 428	0.25 to 0.30	97.325
Type : 8A	232	414 to 464	0.25 to 0.28	97.10
Type : 8B	232	414 to 464	0.25 to 0.28	97.10
Type : 9	320	888 to 950	0.17 to 0.18	96
Type : 10	350	1166 to 1300	0.135 to 0.15	95.625
Type : 11	220	910 to 920	0.12 to 0.125	97.25

QWP Mist Eliminator Specifications – Monel Grades				
QWP Type	Density Kg/m ³	Wire Surface Area m ² /m ³	Wire dia. mm	Free Volume %
Type : 1M	80	129 to 145	0.25 to 0.28	99.10
Type : 2M	110	178 to 200	0.25 to 0.28	98.75
Type : 3M	128	207 to 232	0.25 to 0.28	98.54
Type : 4M	144	233 to 261	0.25 to 0.28	98.36
Type : 5M	173	280 to 314	0.24 to 0.28	98.03
Type : 6M	193	313 to 360	0.25 to 0.28	97.80
Type : 7M	214	355 to 389	0.25 to 0.28	97.56

Standard Grid Specifications			
Grid Specifications	Width mm	Thickness mm	Material
Flat Bar Specifications	15 to 50 MM	2.0MM to 6MM	Same as Mist Eliminator Type
Rod Specification	Round	4.0MM to 10MM	Same as Mist Eliminator Type

Standard Material of Construction for Mist Eliminators:
Mist Eliminators are manufactured in all grades of Stainless Steel and other special alloy like Monel, Inconel, Alloy 20, Hastelloy & Titanium.

Typical Mist Eliminator Fastener Details:
Tie Wire, J Bolts, I Bolts, Cleats and "L" Angles.

QWP Vane type Mist Eliminator Specifications

Qwp type	App. Density Kg/cm	Surface area S.M./cm	Voidage %	Ht (mm)	Pass No.	Hooks 10mm	Spacing mm	Sheet Thk. (mm)	F (m.K.S.) 2500 k/h/sm	Dp (mmw) For F	Approx max achievable eff.(%) For10m
V-1	138	67	98.3	210	3	No	38	0.5	3.4	14	54
V-2	184	91	97.7	210	3	Yes	38	0.5	3.4	27	72
V-3	208	103	97.4	250	4	No	25	0.5	3.4	15	69
V-3.1	204	101	97.5	190	3	No	25	0.5	3.4	13	63
V-3.2	350		69	250	4	No	25	1.0			
V-4	280	139	98.5	250	4	Yes	25	0.5	3.4	33	93
V-4.1	272	135	96.6	190	3	Yes	25	0.5	3.4	29	84
V-5	528	261	93.4	230	7	No	10	0.5	3.4	32	99
V-6	104	51	98.7	250	4	No	50	0.5	3.55	15	55
V-7	140	69	98.3	250	4	Yes	50	0.5	3.75	28	73
V-8.1	104	51	98.7	210	3	No	50	0.5	3.7	13	50
V-7.1	140	69	98.3	210	3	Yes	50	0.5	3.8	24	68
V-10	384	190	95.2	200	3	No	12.5	0.5	4.7	35	97.5
V-10.1	384	190	95.2	200	3	Yes	12.5	0.5	6.1	27	97.5

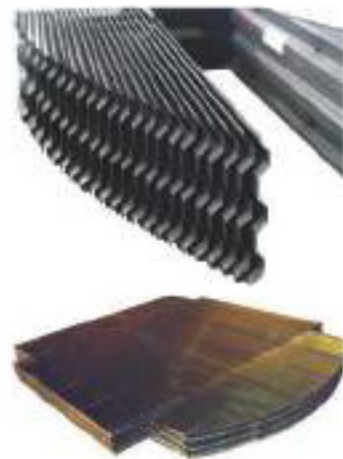
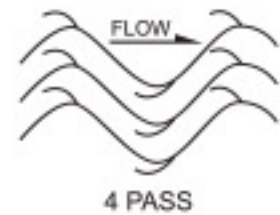
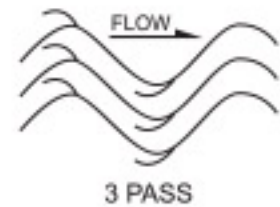

RAW MATERIAL FOR VANE TYPE MIST ELIMINATORS

Stainless steel all grades	Carbon steel grade	Monel 400	Inconel all grades	Poly propylene
Teflon	Non metallic type	Alloy 625	Titanium	Hastelloy
RAW MATERIAL FOR VANE TYPE MIST ELIMINATORS				
Threaded bar from 10mm to 25mm	J bolts and I bolts	Optional perforated plates on top	m10 nuts to m25 nuts	10 mm spacers to 50mm spacers

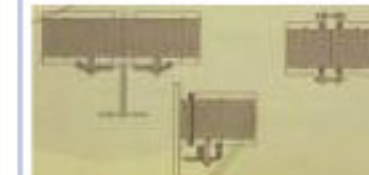
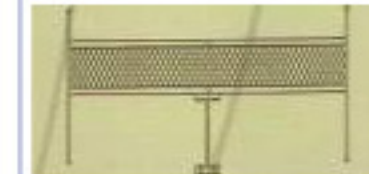
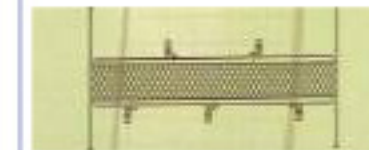
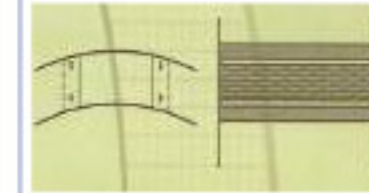
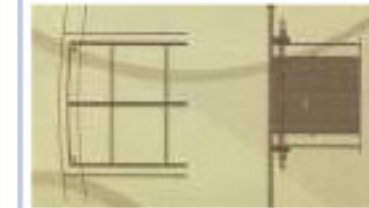
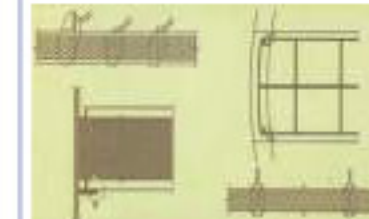

MIST ELIMINATOR INSTALLATION MANUAL:

Mist Eliminator/Demister Pads are manufactured and supplied in segments with grids build over the pads. The segments are installed inside the equipments/vessel as per the drawings and we hereby provide the basic procedure for the demisters. Installation is divided into two parts whereby one is fastening method and the other is support arrangements.

Fastening Methods:

1. Fastening Method -Tie Wire:

Metal wire is supplied with the mist eliminator to secure it to the ring. This is one of the simplest and most common methods where there is a base support like angle or beam and the unit is installed from the bottom or inlet side. The above method requires holes of approximately 6MM diameter to be drilled in the support on approximately 100MM to 125MM centers. In the correct position, tie each one by four place by passing a piece of wire over the grid and through a hole into the ring. Twist the end of the tie wire and bend them to prevent injury.

2. Fastening Method – J Bolts:

J Bolts are also used in installations where you have immediate access to the support to the support ring Four J bolts per segment are required. The most common sizes are 6MM and 9MM. They produced a more secure support than tie wire and are typically used in applications where the installation is required to be very firm. There are two ways to use J-Bolts. They can pass directly through holes in the support ring or through a clamp that catches the support ring. In both cases the J portion of the Bolts holds to the grid and is tightened from the bottom by using nuts.

3. Fastening Method – I Bolts:

In some applications I-Bolt are used. "I-Bolt" assembly consists of a pipe sleeve (typically two or four per segment depending on customer request) inserted through the mist eliminator and located around the grid just above the support ring. When the segments are installed, holes are drilled over the support ring using the sleeves to mark the correct location. Specified size bolts (the I-Bolts) are installed through the pipe sleeves and supports, and fastened with two nuts.

Support Arrangements:

Three types of support arrangement are used most commonly depending upon the diameter or size of the mesh pad as follows.

1. Support Systems – Support Ring:

Two supports consist of two rings, one on either side of the mesh pad unit being installed. This is a common method to hold a mist eliminator for vertical or horizontal mesh pad locations. A two support ring arrangement has removable segments on the side of the man-way that are bolted back in place after the last mist eliminator is installed. If the diameter of the mesh pad is small then support ring in the circumference is sufficient to hold the demister. Max dia will be 1000MM whereby mist eliminator can be installed with only support ring.

2. Angle Support:

Angles are mostly used for holding the demisters if the diameter of the mesh pad is between 1000MM to 3000MM. Angles are welded to the vessel on top and bottom at certain intervals to hold the demister in the same level. Angle support are used along with support ring arrangements.

3. Support Systems – I Beam:

I-Beam, or channel, Hold-Down Beams are mostly used for installations performed from the top and they run vertical to the mist eliminator segments. Hold – Down beams can be bolted to cleats on the vessel wall just above the Mist eliminator once the unit is in place. If the diameter of the mesh pad is big say above 3000MM then apart from support ring (on the circumference) centre support beam is also required to hold the demister.

4. Special Supports Arrangements:

Apart from general support arrangements some unit requires special mist eliminator supporting systems and enclosed typical drawing of the same.

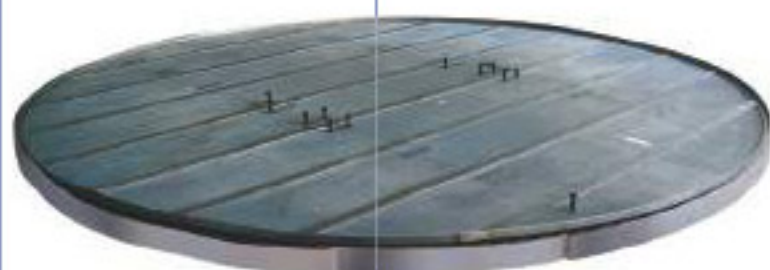
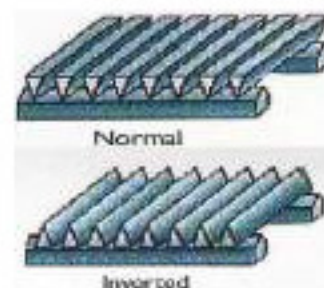
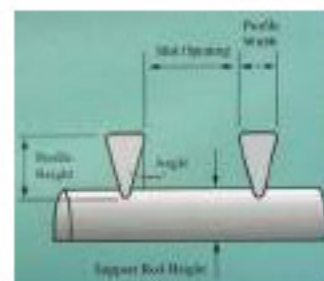
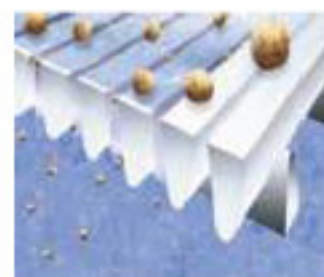
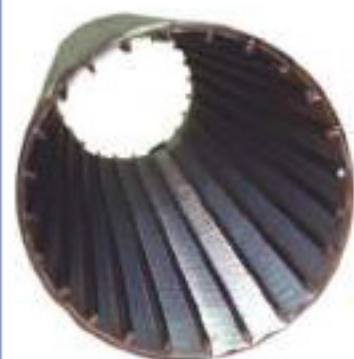

WEDGE WIRE SPECIFICATIONS

Number	Width in mm	Height in mm	Angle	Min. slot Opening mm
Q - 30	0.75	1.30	13°	Minimum slot opening @ ±0.05MM
Q - 43	1.10	2.20	13°	
Q - 63	1.52	2.54	13°	
Q - 80	2.00	4.15	08°	
Q - 90	2.26	3.53	13°	
Q - 109	2.82	4.45	13°	
Q - 128	3.00	5.60	13°	
Q - 133	3.35	6.20	13°	
Q - 138	3.50	6.60	13°	
Q - 155	3.90	6.81	13°	

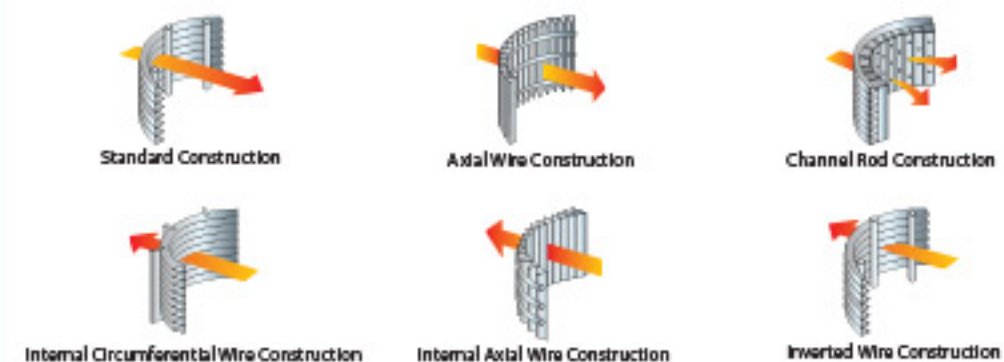

WEDGE WIRE SCREENS:

Wedge Wire Screens are manufactured by Triangular wires rigidly welded to rods or flat bars to form a precise opening. These fabricated screens offer narrow opening with high strength which normal wire mesh screens cannot offer.

CONSTRUCTION:

Wedge wire screen are offered in normal construction and inverted construction. The total thickness of the construction is calculated as follows.

$$T = \text{Profile Wire Height} + \text{Support Height} - (1\text{MM}) \text{ welding penetration}$$

Wedge Wire Screens are used as:

- Liquid / Solids Separation
- Solid Removal From Process Wastewater
- Salt Water Intake Screens & Fiber Removal Screens
- Cylinder for Rotary Screens
- Recovering Solids & Pulp's Thickening Applications
- Heavy Media Recovery & Product Dewatering Screens
- Sieve Bend Screens & In-line Strainers
- Resin Traps & Pressure Screens
- Strainers for Pumps or Compressor Protection
- Support Grid For Uniform Fluid Collection In Filter
- Hub & Header Lateral Screens Systems
- Nozzles for Tube Sheets
- Up flow Clarifiers; Gravity Filters Under Drain Systems

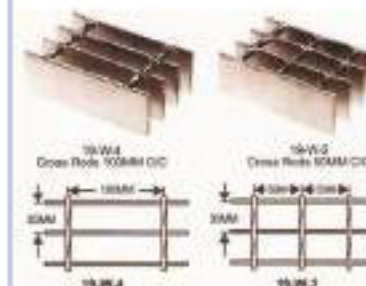

Support Beds

Quality Wire Products Co. W.L.L design and install all types of wedge wire screen based catalyst/packed beds in different column sizes. The fixed support grid is made of wedge wire screen with further reinforcement specially designed to withstand the higher load usually in stainless steel and other grades.

Hold down Grids

The hold down grids is designed with upper and lower stop rings to prevent the lifting or crushing of the bed. The grids are designed in line with customer requirements such as grating open area percentage, the positioning of lower stop ring and upper rings with respect to Catalyst balls

Bottom Support Grids

One of the most important parts of the entire column is the bottom support grids.

These grids are to be carefully designed to withstand the load of the entire bed. Operating parameters such as differential pressure, bending stress etc are important when designing the beds.

The structural beds are provided with the design of support material such as beams, channels etc depending on the load factor.

We provide design and calculation sheets for Clip Analysis, Support Ring Analysis, Support Beam Analysis, Cleat & support analysis, Grating bed analysis, and Wedge wire screen analysis.

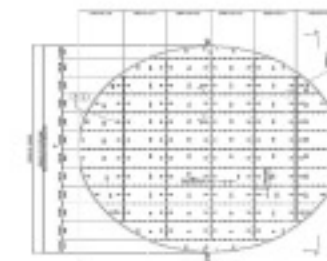

Standard Specifications for Stainless Steel Gratings in Mild Steel and Galvanized

Bar Size D x W (mm)	Bearing Bar Spacing	Cross Bar Spacing	Bar Size D x W (mm)	Bearing Bar Spacing	Cross Bar Spacing
20 x 3	30	100	55 x 4 /5	30	100
25 x 3	30	100	60 x 4 /5	30	100
30 x 3	30	100	20 x 4 /5	30	50
35 x 3	30	100	25 x 4 /5	30	50
20 x 4 /5	30	100	30 x 4 /5	30	50
25 x 4 /5	30	100	35 x 4 /5	30	50
30 x 4 /5	30	100	50 x 4 /5	30	50
35 x 4 /5	30	100	50 x 4 /5	30	50
50 x 4 /5	30	100	55 x 4 /5	30	50
60 x 4 /5	30	100	60 x 4 /5	30	50

Custom Made Grating

Bar Size D X W (mm)	Bearing Bar Spacing	Cross Bar Spacing
10 to 60 X 2 to 6	30 - 100	25 - 100

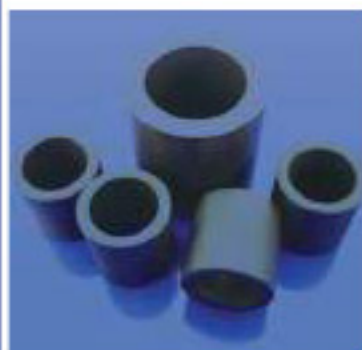

TOWER PACKINGS AND STRUCTURED PACKINGS:

Quality Wire offer the following packing internals which are used in the refinery and gas processing industry and mass transfer applications.

QWP Progressive Metal Packing:

Quality Wire Progressive Metal Packing (QWPMP) is made of metal sheets and give the best performance with relation to low pressure drop and high efficiency. These Packings are made in progressive die tool with complete precision to ensure the best quality. Common Sizes Available is 12; 25; 40; 50 & 70. These random Packings available in various metals such as carbon steel, Stainless Steel all grades and other special alloy steel grades. The below Packings are equivalent to other international brand types.

Type	Piece Density Pcs/M3	Surface Area M2/M3	Void age %	Approx Bulk Weight Kg/M3
QWPMPi -15	347500	291.3	96.60	280 to 284 Kg/M3
QWPMPi - 25	135000	226.8	96.60	222 to 226 Kg/M3
QWPMPi - 40	50000	160.8	97.70	151 to 155 Kg/M3
QWPMPi - 50	15000	100	98	164 to 168 Kg/M3
QWPMPi - 70	4625	690	98.60	138 to 144 Kg/M3

QWP Q – PAK Metal Packing:

Q-Pak is once again a progressive die tool products and Q Pak is an excellent improvisation of the traditional pall rings and is considered to be the most efficient ring type packing. With more numbers of internal strips the interactive area increases for gas liquid contact so these type of rings maintains the efficiency of packing when compared to normal pall rings. With the same efficiency it gives lower pressure drop than pall ring. Due to the special design the thickness of the rings are reduced, reducing investment cost while replacing pall rings with the same.

Type	Piece Density Pcs/M3	Surface Area M2/M3	Void age %	Approx Bulk Weight Kg/M3
QWPQ-PAK1- 30MM	30000	171.9	96.5	260 to 264 Kg/M3
QWPQ-PAK1.5-45MM	9400	118.03	97.04	178 to 282 Kg/M3
QWPQ- PAK2-60MM	3870	84.10	97.4	158 to 164 Kg/M3
QWPQ- PAK3-90MM	1100	57.10	97.7	178 to 184 Kg/M3

QWP PALL RINGS:

Traditional Pall Rings are simple rings with no internal strips mostly used as replacement tools. They are available in metal, plastic and ceramic. In most applications these rings are replaced by internal strips rings (Q-Pak) due to better performance. These rings are used in the heat transfer applications; absorbers and scrubbing and stripper application.

Type	Piece Density Pcs/M3	Surface Area M2/M3	Void age %	Approx Bulk Weight Kg/M3
QWPQ-Pall Ring 16MM	214000	344.20	93.10	530 to 540 Kg/M3
QWPQ-Pall Ring 25MM	51000	206.70	94.80	322 to 328 Kg/M3
QWPQ-Pall Ring 38MM	14300	130.40	96.08	205 to 210 Kg/M3
QWPQ-Pall Ring 50MM	6500	102.10	95.90	195 to 200 Kg/M3

QWP Carbon Raschig Rings:

Raschig Rings are made from Carbon or Graphite used in specific applications to withstand good corrosion and thermal shock resistance. They are resistant to most acids; alkalis and solvents at high temperature and also display good erosion and thermal shock resistance. At the same time they have high crushing strength thus have a long life. They are available in variable sizes such as 10MM, 19MM, 50MM & 75MM.



STRUCTURED PACKING FOR DISTILLATION COLUMNS:

QWP MAKE STRUCTURED PACKINGS are effectively used for separation application in the gas processing plants; Chemical Processing Industries & in the Oil & Gas industries typically for separation applications.

Two Types of structured Packing's are most used common packing and below are the details.

Metal Structured Packing:-

- Wire Mesh Gauze Structured Packing
- Sheet metal Structured Packing in Carbon Steel
- Sheet Metal Structured Packing in Stainless Steel
- Sheet Metal Structured Packing in Nickel alloys

NON Metallic Extruded Structured Packing:-

- PVC; PP; PVDF & TEFLON – Non metallic Structured Packing's

Design & Supply:

Our in house process engineers design and supply various types of structured Packing's depending upon the requirements along with support beds and other internals according to the needs of the end user. QWP Make Metallic Structured Packing are manufactured in thin

sheets with thickness range from 0.10MM to 0.40MM thin strips are knurled to form a rough surface on single or both the sides and then further perforated for the liquids to drain through the holes and finally corrugated in 45° or 60° or in curved shape according to the process requirements. QWP Make structured Packing's are fabricated from 100MM (4Inch) dia to 8000MM dia (315Inches) dia with each segment thickness from 150MM to 250MM and made in segments suitable to pass through the manhole. Several segments are installed inside the columns with each segment installed exactly at 90° opposite direction inside the columns for the best performance.

Supports/Gratings:

QWP Make structured Packing's are installed together with QWP Make support gratings made out of flat bar; expanded metal or perforated sheet or with QWP Make wedge wire screen. Wide open area is created in the supports at the same time supports are reinforced to handle the entire process load including the differential pressure. Our trained staffs help identify the suitable support for different application according to the end user requirements. For best performance of QWP Make structured Packing's, please use the QWP recommended supports.

QWP Make Typical Metallic Structured Packing Type	Surface M2/M3	Voidage %	Factor(F) M3/sec (Kg/M3)	Type of Corrugation
QWP – Type : 1	125M2/M3	98.5 %	1.0 – 3.0	45° or 60° or Curve
QWP – Type : 2	250M2/M3	97.5 %	0.8 – 2.5	45° or 60° or Curve
QWP – Type : 3	350M2/M3	96.5 %	1.0 – 2.5	45° or 60° or Curve
QWP – Type : 4	500M2/M3	97 %	2.0 – 2.5	45° or 60° or Curve
QWP – Type : 5	500M2/M3	95 %	0.6 to 1.8	45° or 60° or Curve
QWP – Type : 6	750M2/M3	95.7 %	1.5 – 2.0	45° or 60° or Curve



QWP STRAINERS

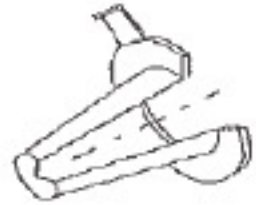

TYPICAL STRAINER

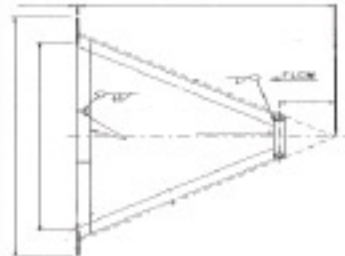

QWP TYPE 1.1 to 1.9

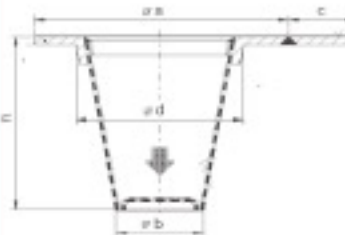

QWP TYPE : 2

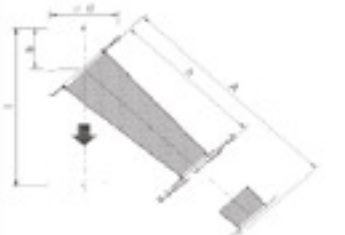

QWP TYPE : t3



QWP STRAINERS

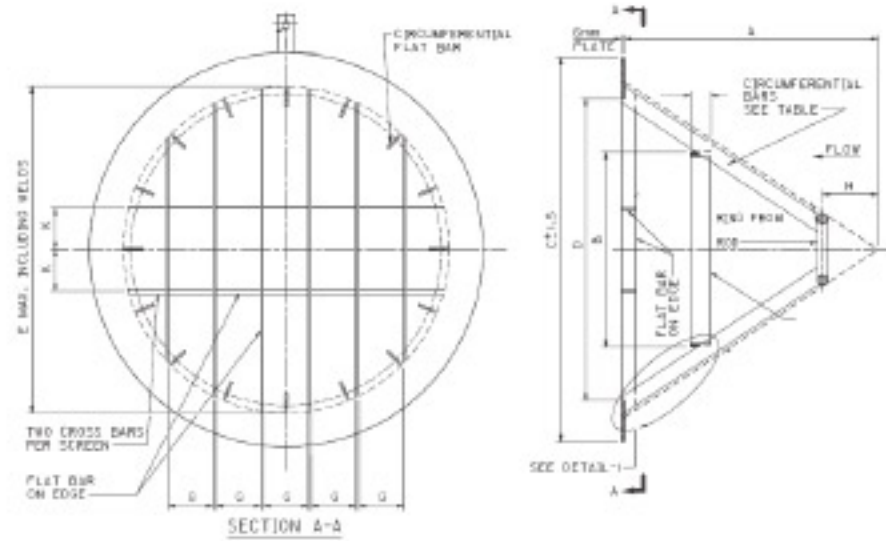

Model	PIPE SIZE in.	ϕ mm	B mm	C mm	D mm	E mm	H mm	ALLOWABLE PRESSURE DIFFERENCE OVER SCREEN KPa
QWP TYPE 1.1	16	380	-	505	320	360	100	193
QWP TYPE 1.2	20	500	280	600	440	470	120	290
QWP TYPE 1.3	24	640	320	710	540	570	160	159
QWP TYPE 1.4	30	840	440	875	680	720	200	179
QWP TYPE 1.5	32	880	460	930	740	770	200	221
QWP TYPE 1.6	34	940	480	980	780	820	200	179
QWP TYPE 1.7	38	1000	500	1040	840	870	200	193
QWP TYPE 1.8	40	1160	560	1155	940	970	200	165
QWP TYPE 1.9	42	1240	580	1210	1000	1030	200	145

Strainers are used in steam, water, oil or gas where protection from foreign matter in a pipeline is required. Perforated Sheets are rolled and formed into a conical shape with additional layers of wire mesh spot welded to the conical strainer. These strainers have the desired open area and are fabricated to withstand the required pressure drop. Additional reinforcements can be made on the strainers if required.

Model	PIPE SIZE in.	ϕ mm	B mm	C mm	D mm	E mm	H mm	ALLOWABLE PRESSURE DIFFERENCE OVER SCREEN KPa
QWP TYPE 2 & 3	Please specify the above data and we shall fabricate the strainer and supply the same							

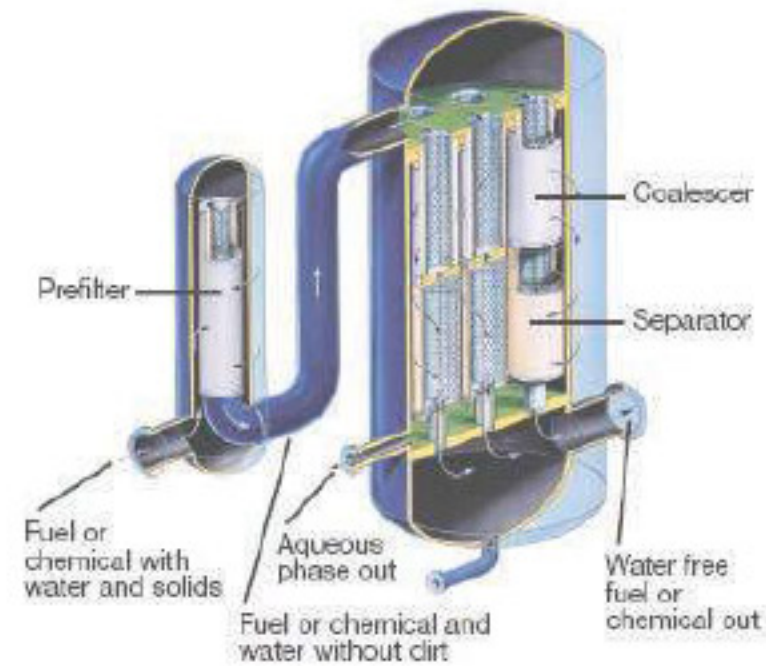

A Coalescer is a technological device performing coalescence. They are primarily used to separate emulsions in to their components via various processes; operating in reverse to an emulsifier.

In the area of compressed air purification, coalescing filters are used to separate liquid water and oil from compressed air using a coalescing effect. These filters additionally remove particles.

Liquid-Gas coalescers in the Oil and Gas, Petrochemical and Oil Refining industries, Liquid-Gas coalescers are widely used to remove water and hydrocarbon liquids to <0.011 ppm (plus particulate matter to <0.3 um in size) from natural gas to ensure natural gas quality and protect downstream equipment such as compressors, gas turbines, amine or glycol absorbers, molecular sieves, PSA's, metering stations, mercury guard beds, gas fired heaters or furnaces, heat exchangers or gas-gas purification membranes.

Liquid-liquid coalescers are widely used in oil refining industry to remove contaminants like amine or caustic from intermediate products in oil refineries and also for dewatering final products like kerosene (jet fuel), LPG, gasoline and diesel to <15 ppm free water in the hydrocarbon phase.

Phases up liquid-liquid coalescers can also be used to separate hydrocarbons from water phases such as oil removal from produced water. They have been also used in pyrolysis gasoline (benzene) removal from quench water in ethylene plants. We make both Plate and Knitted Mesh coalescers in stainless steel and nickel and copper alloy materials. Depending upon the requirement they can be used solely or in combination to separate a wide range mechanically induced emulsions. Hydrophobic and hydrophilic materials are available to achieve desired separation results. All separator packs are built to customer specifications or performance requirements and designed for high efficiency and long reliable service.

Advantages are cost savings due to smaller vessel size, Increase in capacity for existing vessels. Savings due to recovery of solvents. Better product quality. Reduced tank inventory and Compliance with regulatory laws

We make both Plate and Knitted Mesh coalescers in stainless steel and nickel and copper alloy materials. Depending upon the requirement they can be used solely or in combination to separate a wide range mechanically induced emulsions. Hydrophobic and hydrophilic materials are available to achieve desired separation results. All separator packs are built to customer specifications or performance requirements and designed for high efficiency and long reliable service.

Advantages are cost savings due to smaller vessel size, Increase in capacity for existing vessels. Savings due to recovery of solvents. Better product quality. Reduced tank inventory and Compliance with regulatory law.



TYPICAL QWP SYTLE COALASCERS	Density [kg/m³]	Wire dia mm	Surface m²/m³	Free Volume %	Remarks
Metallic types					
QWP -Coalascer -Type 5	144	0.25 to 0.28	344 to 386	97.68	Aqueous phase is dispersed
QWP -Coalascer -Type 7	193	0.25 to 0.28	344 to 386	97.68	
QWP -Coalascer -Type 8A	232	0.25 to 0.28	414 to 464	97.1	
Non-metallic types					
QWP-Type : 1 Coalascer (Polypropylene)	72	0.39 to 0.40	760 to 790	92,3	Organic phase is dispersed
QWP-Type : 2 Coalascer (Polypropylene)	102	0.215 to 0.225	1990 to 2040	89,0	
QWP-Type : 5 Coalascer (Polypropylene)	144	0.39 to 0.40	1590 to 1620	94,0	
QWP-Type : 5 Coalascer (DACRON)	145	0.265 to 0.275	360	91,9	

Metal & Plastic Co Knit	Density [kg/m³]	Surface m²/m³	Free Volume %	Remarks
QWP Type -8- Coalascer SS/Glass fibre	200	5000	94,8	High efficiency
QWP Type -8A- Coalascer SS/Glass fibre	240	6000	93,7	
QWP-Type-7-Coalascer-SS/Polypropylene	192	676	94,0	High flexibility
QWP Type 8ACoalascer-SS/Polypropylene	240	845	92,5	
QWP Type -8- Coalascer GSF/PP	200	8000	93,1	High efficiency

Corrugated Sheet Metal Coalascers	Density [kg/m³]	Sheet Thick	Surface	Angle	Remarks
QWP – Type : 1 Structured Packing	200	0.20	250M2/M3	45 Deg or 60 Degree	High performance
QWP – Type : 2 Structured Packing	50 to 100	0.10 to 0.15	125M2/M3	45 Deg or 60 Degree	For light liquid and for high foams



NOTICE

While every effort has been made to ensure the accuracy of the information within this publication, the use of the information is at the readers risk and no warranty is implied or expressed by Quality Wire Company W.L.L with respect to the use of information contained herein.

The information in this publication is subject to change or modification without notice.



www.qualitywire.com.bh

Head office / Factory

Quality Wire Products Co. WLL

Bldg. No. 86, Road 19, Block 115, Salman Industrial City, Hidd
Kingdom of Bahrain, P. O. Box 33450
Tel.:+973 17874000 / 17456343, Fax: +973 17874111 / 17456312
quality@batelco.com.bh / sales.bahrain@qualitywire.com.bh

Warehouse / Office - Sharjah

Quality Wire Products OET (SHJ) LLC

P. O. Box 44377, Sharjah - UAE
Tel.:+971 6 5357 007 / 6 5357 061, dxbqwp@qualitywire.com.bh

Sales Office - Qatar

Quality Wire Products Company

Logic Real Estate Building, P. O. Box 24692, Doha Jadeed - Qatar
Tel.:+974 44416175, Fax: +974 44417292, sales@qualitywireqatar.com

Sales Office - Abu Dhabi

Quality Wire Products OET LLC

P. O. Box 36218, Abu Dhabi - UAE
Tel.:+971 2 4952772 / 2 6749966, dxbqwp@qualitywire.com.bh

Warehouse / Office - Oman

Quality Wire Products Co LLC

Shop No.40,41,50,51 P.O.Box 770 PC 320, Barka Industrial Area
Tel: +96891194526/91711553/26983198/26983197, omanqwp@qualitywire.com.bh

Warehouse / Office - Kingdom of Saudi Arabia

Foundation of Good Trade Wire Products

Jubail, Albuainain Agency, The Swedish Industrial Neighborhood
Abu Saad, Block-5, Building:6, P. O. Box 35102, Zip Code:31967
Tel.:+966 013 367 2825, Fax: +966 013 367 2827, saudi@qualitywire.com.bh